

inspired™

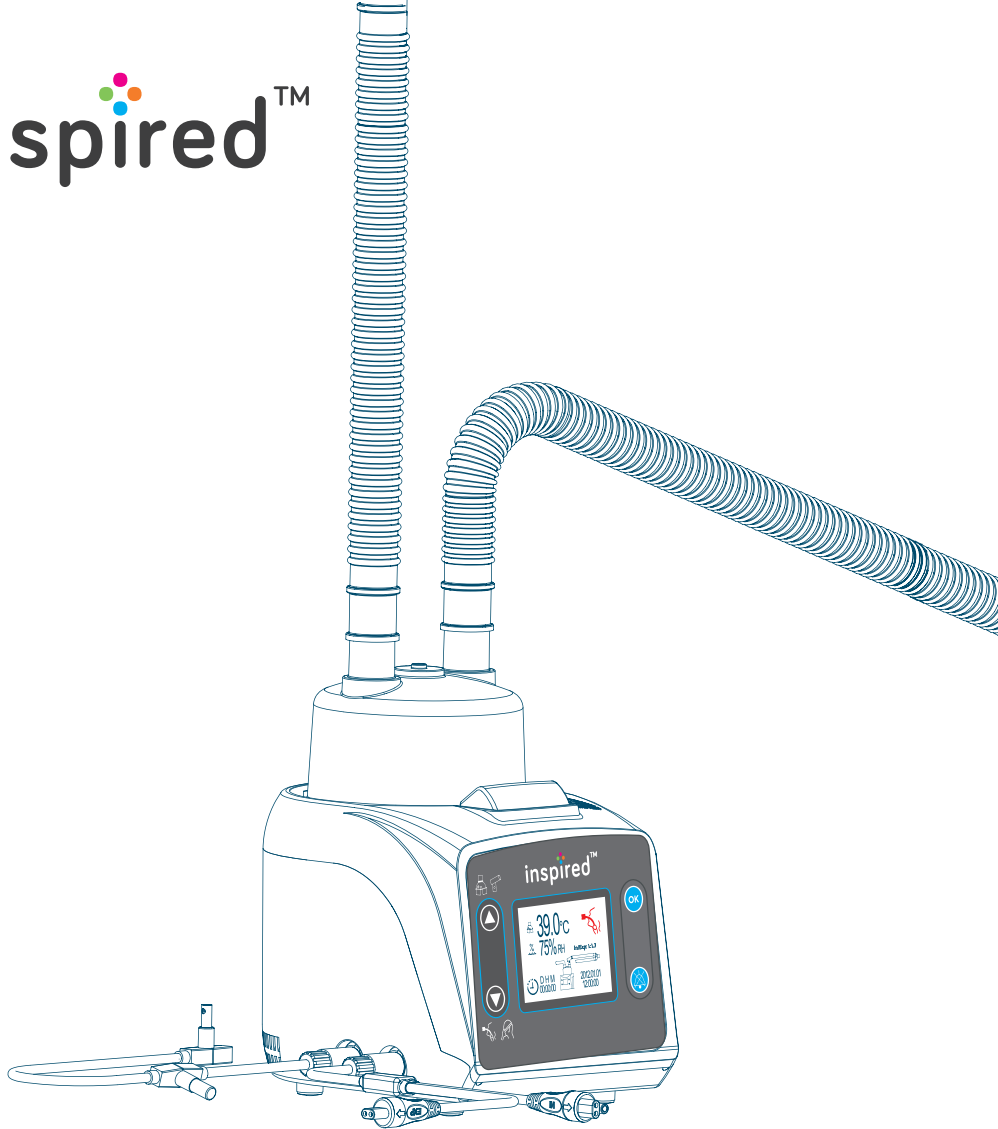

VHB20 Series Heated Humidifier

OPERATOR'S MANUAL

P/N: 10022868 Revision: A Issued Date: 14 Nov.2018

Thank you for purchasing the VHB20 Series humidifier.

VHB20 Series Software released version: 2

Before using this product, please read the manual.

Intellectual Property Rights

This manual and its corresponding Intellectual Property Rights belong to VINCENT MEDICAL MANUFACTURING CO., LTD.

Without Vincent Medical Manufacturing Co., Ltd.'s written consent, any individual or organization must not copy, modify, translate or use any part of the manual.

Contents

Chapter 1 INTRODUCTION

-----	01
1.1 Intended Use -----	01
1.2 Main Performance and Technical Specification -----	01
1.3 Product Overview (see figure 1) -----	02
1.4 Packing List -----	03
1.5 Control Panel -----	03

Chapter 2 SAFETY MANAGEMENT

-----	05
2.1 Safety Classification -----	05
2.2 System Symbols -----	06
2.3 Cautions & Warnings -----	06
2.4 Environmental Conditions -----	09
2.5 Safety Features -----	09
2.6 Environmental Protection -----	09

Chapter 3 STORAGE AND MAINTENANCE

-----	09
3.1 Cleaning the Humidifier -----	09
3.2 Storage and Transportation -----	10
3.3 Battery Information -----	10
3.4 Routine Inspection -----	10

Chapter 4 HUMIDIFIER SETUP

----- 11

Chapter 5 SYSTEM OPERATION

----- 12

5.1 Startup/Shutdown -----12

5.2 Operation Mode Selection ----- 12

5.3 Operation Settings ----- 12

5.4 Mute ----- 14

Chapter 6 REPAIR

-----15

6.1 Repair Instruction -----15

6.2 Troubleshooting -----16

Chapter 7 EMC INFORMATION

----- 18

Chapter 8 USE AND WARRANTY PERIOD

-----22

Chapter 1 INTRODUCTION

1.1 Intended Use

The VHB20 Series humidifier is intended to warm and humidify breathing gases delivered to patients. The humidifier automatically maintains the temperature and relative humidity settings as selected by the healthcare professionals.

1.2 Main Performance And Technical Specification

Ratings: 220-240 V \sim , 50/60 Hz.

Power: 320VA, Heater Wire: 24 V $\overline{=}$, 80 VA (MAX).

Heater Plate Over-Heating Cut-off Temperature: 118 \pm 7 $^{\circ}$ C.

Dimension: Length 204mm / Width 150 mm / Height 159 mm.

Weight: 1.9kg without Humidification Chamber.

Patient Side Temperature Range:

Invasive Mode: 35-40 $^{\circ}$ C, Default 39 $^{\circ}$ C.

Non-invasive Mode: 30-37 $^{\circ}$ C, Default 34 $^{\circ}$ C.

Display: LCD.

Probes of temperature-humidity data cable detection range: 0-150 $^{\circ}$ C,

Accuracy: \pm 0.5 $^{\circ}$ C(in 20-45 $^{\circ}$ C temperature range).

Alarm system

1. All the alarms conditions are high priority.
2. All the alarms conditions are technical alarm conditions
3. The maximum alarm condition delay for patient side low temperature, chamber outlet low temperature and patient side low humidity is 22 minutes during start-up and 2 minutes once the humidifier is stabilized. There is no delay for alarm signal generation.
4. The maximum alarm delay for malfunction of probe of chamber outlet or patient side alarm is 10min, and no delay for alarm signal generation.
5. If multiple alarm conditions occur at the same time, the system will alarm following the ranking as shown in line "Alarm priority" of the table in section 6.2, till all the alarm conditions are cleared.
6. Sound Pressure Level exceed 50dBA @ 1m.

7. Operator's position should be less than 30cm away from the device. Specific ALARM CONDITION and its priority should be legible from operator's position.

Audio and Visual Alarm Parameters	High Temperature Alarm	Low Temperature Alarm @ normal running	Low Humidity Alarm @ normal running
Invasive Mode	Patient side Temperature >41°C, immediate alarm	Patient side Temperature <35°C for more than 2mins	Patient side humidity <80% for more than 2mins
Non-invasive mode	Patient side Temperature > 38°C, immediate alarm	Patient side Temperature <30°C for more than 2mins	Patient side humidity<70% for more than 2mins

Please refer to section 6.2 for the complete alarm information.

Performance

Recommended environment operating temperature: VHB20 Series 18-28°C.

Caution: Humidity performance of VHB20 Series can be compromised when used outside the specified environment operating temperature.

Recommended flow range: Invasive Mode: 5 to 60 L/min;

Non-invasive Mode: 5 to 120 L/min.

Humidity performance: Invasive Mode: >33 mg/l, Non-invasive Mode: >10mg/l

Recommended temperature of aspiratory gas: ≤30°C

Warm-up time: ≤25minutes (from a starting temperature of 23 ± 2 °C)

1.3 Product Overview (See figure 1)

01	Chamber Lock Button	02	Front Panel	03	Heater Wire Adaptor
04	Temperature-Humidity Data/Sensor Cable	05	Humidifier Base	06	Heater Plate
07	Mounting Plate	08	Mounting Bracket		

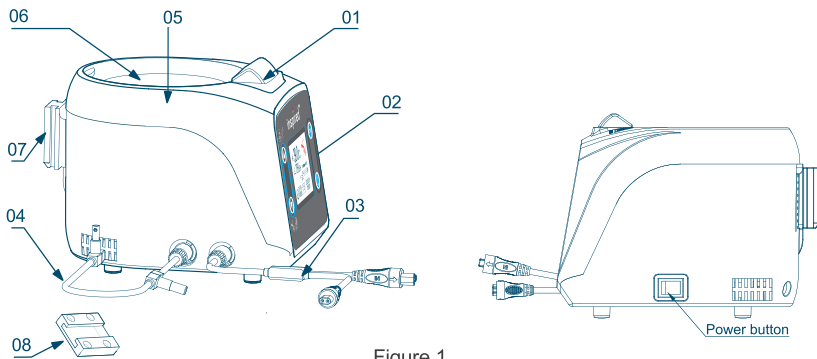

Figure 1

Note:

1. The following additional accessories are required for the operation of the humidifier: Humidification Chamber (e.g.VHC20), Breathing Circuits (e.g. HBC03). Choice of humidification chamber and breathing circuit will depend upon application as set by qualified physicians / clinicians. You can also contact your local supplier or Vincent Medical Manufacturing Co., Ltd. for humidification chamber and breathing circuit options.
2. The gas supply and patient interface are required for the whole system, such as a ventilator or air-supply device.
3. This machine should be earthed correctly for protection against electric shock. The earth wire must not be dismantled or removed. And the machine is properly grounded only when the earth wire is connected to the marked socket.
4. Only use breathing circuits that are prescribed by physicians or clinicians.
5. Use only items that have been specified as part of humidification system or specified as being compatible with the humidification system.
6. Always refer to the manuals of the accompanying accessories or gas supply for the respective information for safety measures, operation, adjustment, cleaning, sterilization, and disinfection procedures, maintenance and permissible environmental conditions of use including conditions for transport and storage.

1.4 Packing list

Humidifier Base	1 PC
Mounting Bracket	1 PC
Temperature-Humidifier Data/ Sensor Cable	1 PC
Heater Wire Adaptor	1 PC
Operator's Manual	1 PC
Quick Guide	1 PC

1.5 Control Panel

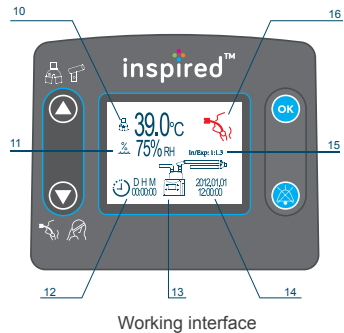
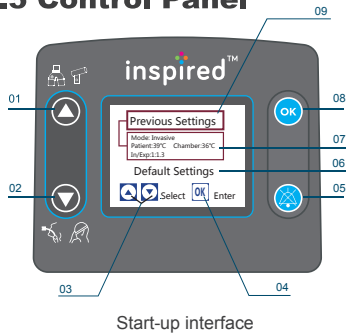

Figure 2

01	Temperature mode button	02	Mode button
03	Selection signal	04	Confirmation signal
05	Mute button	06	Default settings
07	Parameters selection frame	08	Temperature control button
09	Previous settings	10	Display: temperature of patient-side or chamber air outlet
11	Display: relative humidity	12	Display: system time
13	Error message indicator	14	Display: running time
15	Display: Inspiratory / Expiratory	16	Display: Invasive mode or Non-invasive mode

1.5.1 Description of the Control Panel Buttons

Button Name	Function
Temperature mode button	Switch the temperature display between patient-side and humidification chamber air outlet
Mode Button	Switch between Invasive mode and Non-invasive mode
Mute button	Mute any alarm, set time or enter Inspiratory/Expiratory mode setting
Temperature control button	Manually set the default temperature and adjust temperature during operation

1.5.2 Humidifier Display Descriptions

Please refer to section 2.2 System Symbols for an explanation of the display icons.

Note:

Patient side temperature display: in 0.1°C steps.

Patient side humidity display: in 1% steps (maximum of 99%)

1.5.3 Start-up Interface Description

Previous settings	Setting of the previous patient end temperature and Inspiratory/Expiratory ratio
Default settings	Manufacturer default patient end temperature and Inspiratory/Expiratory ratio
Setting Parameters Selection frame (highlight in red color)	For selecting Previous Setting or Default Setting by user
Selection Signal	Indication for user to press ▲ or ▼ to select
Confirmation Signal	Indication for user to press OK to confirm the chosen setting

Chapter 2 SAFETY MANAGEMENT

2.1 Safety Classification

2.1.1 Type of protection against electric shocks

Class I device

2.1.2 Degree of protection against electric shocks

Type BF applied parts

























2.1.3 Mode of Operation

Continuous operation device

2.1.4 Degree of protection against harmful ingress of water

IPX1

2.2 System Symbols

	Type BF Applied Part			Relative humidity	
	Caution			Invasive mode	
IPX1	Drip proof protection to IPX1			Non-invasive mode	
	Warning: Hot surface temperature may exceed 85°C			Running time	
	Electrical shock hazard refer to qualified service personnel			Refer to instruction manual / booklet	
	Do no discard WEEE collection (EU only)			Patient side	
	CE marking			Chamber air outlet side	
	Authorized representative in the European Community			Chamber	
	Protective earth (ground)			"OFF" (power)	
In/Exp	Heating power ratio between inspiratory limb and expiratory limb of breathing circuit			"ON" (power)	
	Serial number			Alternating current	
	Fragile, handle with care			Upward	
DHM	Day/Hour/Minute		Warning		Manufacturer
	U.S. Federal law restricts this device to sale by or on the order of a physician.				

2.3 Cautions & Warnings

Safe and reliable use of this humidifier is dependent on, but is not limited to the following requirements:

- 1) Read Carefully and fully understand the information provided in the manual before using the VHB20 Series humidifier. Use in accordance with the instructions in the manual and as per clinical prescription.
- 2) Use only the correct fuse provided by your local supplier or Vincent Medical Manufacturing Co., Ltd.
- 3) Proper maintenance and inspection of the device should be done by qualified and trained technical personnel.

4) Use the appropriate parts recommended by your local supplier or Vincent Medical Manufacturing Co., Ltd.

5) Use the appropriate power supply and ensure proper grounding.

Warning! The device should only be operated by trained personnel under guidance of a physician. The device can only be sold to qualified clinicians or physicians.

Warning! Comply with best practice: Instructions for Use are not a substitute for established medical procedures. "Best practices" of medical groups and/or the independent association should always be followed.

Warning! Before using the device, the user must understand the use of the device, its applications and safety requirements.

Warning! VHB20 Series is intended to be used in conjunction with gas supply, such as iVent 201 or other Air-Supply device which meets the requirements of IEC 60601-1 and IEC 60601-1-2.

Warning! Do not pour water above the maximum water level marked on the humidification chamber. If overfilled water may enter the patient's breathing circuit.

Warning! Do not pour water that is greater than 37 °C or less than 10 °C into the humidification chamber.

Warning! The heated humidifier is not recommended to be used at less than 5LPM of gas flow when used with non-heated circuits.

Warning! Ensure that invasive mode is set for patients that have bypassed airways.

Warning! Operation: Ensure that the temperature of gas delivery to the patient meets the prescription of the clinician. Conduct regular verification on the operating temperature. Transmitting overheated gas may burn, or cause other hazards to the patients.

Warning! Operation: Ensure correct connections and operation settings

of the device, ventilator or other gas delivery devices to the humidifier before connecting the device to the patient. Ensure the appropriate flow and pressure of gas has been checked.

Warning! Explosion Hazard: Care should be taken when used with or near flammable gases or anaesthetics.

Warning! Do not touch the heater plate. The heater plate may be hot (over 85°C) and may cause burns. Before touching or cleaning the heater plate, ensure that the heater plate has sufficiently cooled down.

Warning! Recommended Accessories: Only manufacturer recommended humidification chambers, respiratory circuits and other accessories should be used. Unauthorised accessories which are not recommended by your local supplier or Vincent Medical Manufacturing Co., Ltd. may impair performance or compromise safety.

Warning! Electric Shock Hazard: Risk of electric shock may occur if the system is not properly grounded. The system uses 220-240VAC. power supply and contains a separate ground wire. The ground wire must not be dismantled or removed. Connect the ground wire to the marked socket to ensure the system is safe and properly grounded.

Warning! Cleaning and Maintenance: The system should be turned off and disconnected from the power supply before cleaning the device.

Warning! Technical maintenance and/or repair should only be conducted by qualified and trained staff.

Warning! Do not soak or sterilize the heated humidifier.

Warning! During extended use, the respiratory circuit will produce condensation. The condensation should be carefully removed from the breathing circuit. It is recommended that the breathing circuit should be installed with a water trap to help remove condensation.

Warning! Keep the connectors of temperature-humidity data / sensor cable and heated wire adaptor dry at all time.

2.4 Environmental Conditions

This product should not be exposed to excessive vibration, dust, corrosive or combustible gases. During use, this product should always be placed in a horizontal position. The recommended environmental conditions for operation are:

Environment temperature: 18-28°C.

Relative humidity: 15-93% non-condensing.

Atmospheric pressure: 86-106 kPa.

Warning! The operation of high frequency surgical apparatus, shortwave or microwave equipment in the vicinity of the humidifier may adversely affect its function. It is recommended that the humidifier should be moved away from such devices.

2.5 Safety Features

If the thermostat is tripped (Over-Heat Cut-off Temperature: 118±7°C), the audio alarm will come on and the device will automatically shut-off.

Caution: If this occurs, please contact a qualified service technician.

2.6 Environmental Protection

At the end of service life, dispose of the device in accordance with local laws and regulations.

Chapter 3 STORAGE AND MAINTENANCE





3.1 Cleaning the humidifier

Ensure that the device is off and disconnected from the power supply. Use a soft damp cloth to clean the surface of the humidifier. After each use, wipe clean data / sensor cable with recommended disinfectants(e.g.

ENDOZIME AW PLUS WITH APA). Ensure the cleaning liquid does not enter the inside of the humidifier during cleaning.

The humidifier cannot be sterilized. Do not apply any hospital sterilization on the humidifier and electrical components, such as autoclaving or ethylene oxide gas sterilization.

Warning:

-  Do Not immerse the humidifier in any liquid.
-  Do Not sterilize the humidifier.
-  Do Not use organic solvents to clean the surface of the humidifier.
-  Do Not immerse the temperature and humidity data / sensor cable in liquid
-  Do Not use caustic liquids or cleansers to clean the temperature and humidity data / sensor cable.

Note: The cleaning / disinfection / sterilization method for accessories or gas supply, please refer to their manual.

3.2 Storage and Transportation

The storage and transportation temperature should be -20°C to 55°C, relative humidity: 15-93%, Atmospheric pressure 86-106Kpa.

Please keep original packaging of the system for storage and transportation protection.

3.3 Battery Information

One 3V Lithium/manganese dioxide battery is installed in the device for the real time clock. Only trained personal should service or replace the battery. Incorrect replacement or service may cause the humidifier to malfunction.

3.4 Routine Inspection

Before each use a visual inspection on the whole device is recommended. Check alarm signals before each use. Plug in mains supply, then switch on the product without plugging in the temperature-humidity data / sensor cable. Then press OK, the symbol  will be displayed, and the audio alarm will sound.

Chapter 4 HUMIDIFIER SETUP

1. Install the Humidification Chamber (A) onto humidifier base and connect the breathing circuit (B) (Refer to the manuals of the humidification chamber and breathing circuit for further details).
2. Connect the plug of the temperature-humidity data / sensor cable (C) to the blue socket on the humidifier base until a click is heard.
3. Push the chamber outlet probe (D) and patient side probe (E) into the breathing circuit. Ensure the patient side probe is parallel to the breathing circuit and also ensure the probes are fully engaged and depressed all the way.
4. Connect the plug of the heater wire adaptor (F) to the red socket on the humidifier base until a click is heard. Connect the other ends (G,H) of the heater wire adaptor to the heater wire circuits(I,J).

The humidifier system is now set up and ready for use. The humidifier will default to Invasive Mode.

- Note:** 1. When using with non-heated wire circuit, skip 4.
2. Please refer to the manual of the ventilator or gas supply for connections between breathing circuits and ventilator.

Caution:

When using a non-heated wire circuit, please monitor the water level in the water trap. Empty the condensation when it reaches the maximum indicated level.

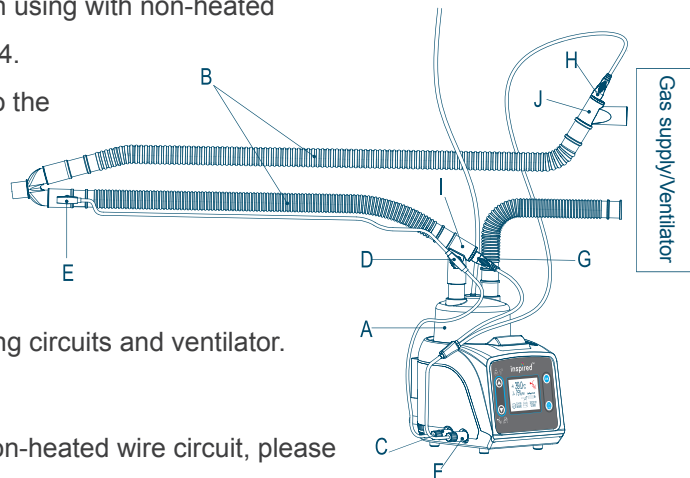

Chapter 5 SYSTEM OPERATION

5.1 Startup/Shutdown

Turn the power switch to ON position to start. Turn power switch to OFF position to shut down.

5.2 Operation Mode Selection

5.2.1

Press the ▲ or ▼ button to select the settings option.

For selecting “Previous settings”, press **OK** to enter a working interface.

For selecting the “Default settings”, press **OK** to enter the next interface to set invasive or non-invasive mode.

Notes: After 10 seconds a warning signal “De – De” will sound and **OK** will flash red to prompt the user to select the required settings.



5.2.2 Set Invasive or Non-invasive Mode

Press ▼ button to switch between Invasive mode and Non-invasive mode, then press **OK** or wait for 3 seconds to confirm.

During usage, press ▼ button for 3 seconds to switch the mode.

5.3 Operation Settings

5.3.1 Set Time and Date

Press the mute button  for 3 seconds. A green background will flash over the Year. Press ▲ or ▼ to select. Press  again to move to month, day, hour or minute. Press ▲ or ▼ to select desired setting for each.

Press **OK** when finished.

5.3.2 Set temperature

(1) Patient side temperature setting

When the temperature icon shows “”, Press **OK** for 3 seconds and the system enters the temperature setting mode. When the temperature symbol “°C” is flashing on the display, the patient-side temperature can be set. In Invasive mode, the default temperature is 39°C. Press **▲** or **▼** for increasing or decreasing the temperature by 0.5°C intervals in the range of 35-40°C; In Non-invasive mode, the default temperature is 34°C. Press **▲** or **▼** for increasing or decreasing the temperature by 0.5°C intervals in the range of 30-37°C. After setting, press **OK** . After 10 seconds with no response during the setup process, the system will exit the setting mode and return to the main page without saving all the parameters.

(2) Chamber air outlet temperature setting

When the temperature icon shows“”, Press **OK** for 3 seconds and the system enters the temperature setting mode. When the temperature symbol “°C” is flashing on the display, the chamber air outlet temperature can be set. In Invasive mode, the default temperature is 36°C, then the patient temperature is 39°C. Press **▲** or **▼** for increasing or decreasing the temperature by 0.5°C intervals in the range of 34~43°C; In Non-invasive mode,the default temperature is 31 °C, and the patient temperature is 34°C. Press **▲** or **▼** for increasing or decreasing the temperature by 0.5°C intervals in the range of 30~32°C. After setting, press **OK** . After 10 seconds with no response during the setup process, the system will exit the setting mode and return to the main page without saving all the parameters.

5.3.3 Set “IN/EXP”





Press **OK** for 3 seconds and the system enters the temperature setting mode. Then press  to enter the "IN/EXP" setting mode, the default ratio is 1:1.3. Press **▲** or **▼** for increasing or decreasing the proportion of EXP in the range of 1 to 1.5. After setting, press **OK**. After 10 seconds with no response during the setup process, the system will exit the setting mode and return to the main page without saving the parameter.

Note: When condensation in the expiratory limb increases, increase the proportion of EXP.

5.3.4 Switch the temperature display between chamber air outlet and patient side.

During operation press the Temperature Mode Button to monitor the temperature of the chamber air outlet side. After 5 seconds, the system will automatically show the temperature of the patient side.

5.3.5 Non-dual Heated Wire Operation

When using single limb heated wire circuits or non heated wire circuits, in the working interface, the error message indicator should display  or , press the OK button to confirm, display  for the use of single limb heated wire circuits, show  for the use of non heated wire circuits.

5.4 Mute

When the alarm sounds, press the mute button  to silence. After correcting the malfunction, the system alarm will reset itself to normal. The alarm will sound again within 1.5 minutes if the identified malfunction is not corrected.

Note: If using with non-heated wire circuits, system with alarm. Press  to mute and press **OK** to return to normal.

Chapter 6 REPAIR

Warning! Repairs must be carried out by an authorised trained technician.

6.1 Repair Instruction

For any issue regarding repairing or replacement of parts please contact your local supplier or Vincent Medical Manufacturing Co., Ltd. Installers and operators must comply with the instructions of the equipment installation, operation, inspection and maintenance.

Maintenance personnel must be authorized by Vincent Medical Manufacturing Co., Ltd. Vincent Medical Manufacturing Co., Ltd. is not responsible for the safety and reliability of the equipment or device performance if the repairs are not carried out by an authorized trained technician or the following:

- ★ Modifying or repairing the device without authority from Vincent Medical Manufacturing Co., Ltd.
- ★ Non-recommended factory parts are used
- ★ Electrical power source is not compatible with local regulations
- ★ Use of the device is not in accordance with the instruction manual

We recommend that you obtain the following information from any personnel performing maintenance or repairs:

- ★ Nature and scope of maintenance and/or repairs to be conducted
- ★ Changes or modification to the device
- ★ Maintenance date

★ Maintenance staff or company name



★ Maintenance staff signature





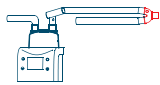

Any repairs or maintenance conducted by non-qualified personnel and not in conformance with the manual is a violation of the warranty.

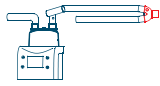
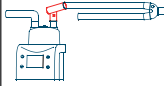
6.2 Troubleshooting

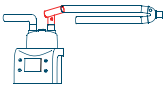
Refer below for troubleshooting guidance.

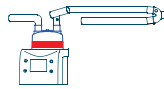
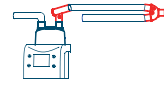
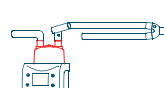
Note: In below diagram, red indicates that the parts/symbols are flashing.

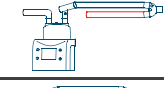
Error Message	Alarm Priority	Possible Cause of the Malfunction	Corrective Action
 <p>The patient-side temperature data display on the LCD will flash in red.</p>	1	Patient-side temperature > high temperature alarm limit (invasive 41°C, non-invasive 38°C)	Turn the power off, wait for the temperature to decline and then turn on the power. If red flashing continues, disconnect and use new unit. Contact local supplier.
	2	Patient side temperature < low temperature alarm (invasive 34°C, non-invasive 29°C)	Press  to mute the alarm and extend the heating time. Verify ambient temperature is not below operating range. If yes, check the air conditioning whether the room temperature is too cold.
 <p>The patient-side temperature will display as “--” and flash in red</p>	7	Malfunction of the patient side probe	Replace temperature-humidity data / sensor cable.
 <p>The chamber outlet temperature data displayed on the LCD is lower than 29°C and flash in red</p>	3	The chamber outlet temperature < 29°C (Only for invasive mode)	1. Check whether the temperature probe is installed correctly. 2. Check if the chamber has water or not

 <p>The chamber outlet temperature data will display as "--" and flash in red</p>	6	Malfunction of the chamber outlet probe	Replace the data / sensor cable.
Relative humidity data on LCD will flash in red	4	<ol style="list-style-type: none"> 1. Flow or room temperature exceeds allowable range. 2. Data /sensor cable failure 3. Chamber run out of water results in humidity less than 80% (Invasive) or 70% (Non-invasive) for 2 mintues continuously after start up for 20 minutes. 	<ol style="list-style-type: none"> 1.Check the flow or room temperature if it's in the range recommended. 2.Check temperature-humidity data / sensor cable and replace if it is damaged. Otherwise press  to mute the alarm. If alarm recurs, contact maintenance or local supplier. 3.Check if water-out or not.
	5	Humidification chamber has no water.	Add water to the humidification chamber and restart the product.
	8	Temperature-humidity data / sensor cable is unplugged, or Malfunction of temperature-humidity data / sensor cable probe	<ol style="list-style-type: none"> 1.Securely plug in the temperature-humidity data sensor cable. 2.Replace the temperature-humidity data / sensor cable.
	9	<ol style="list-style-type: none"> 1.Chamber is not installed or incorrectly installed. 2.Heater plate is damaged or open circuit. 3. Thermal cut-out at the bottom of heater plate (exceeds 118±7°C). 	<ol style="list-style-type: none"> 1.Install chamber correctly. 2.Contact maintenance.
 <p>or</p> 	10	<ol style="list-style-type: none"> 1.Heated wire adapter is not plugged in. 2.Malfunction of heated wire circuit. 3. Heated Wire Adapter is faulty. 	<ol style="list-style-type: none"> 1.Securely plug in heated wire adapter. 2.Replace the heated wire circuit. 3. Replace heated wire adapter.
 <p>Chamber symbol is flashing</p>	Not alarm	Malfunction of heater plate sensor.	Contact maintenance or local supplier.

Chapter 7 EMC INFORMATION

The electromagnetic compatibility (EMC) of the VHB20 Series humidifier is designed according to IEC60601-1-2 Medical Electrical Equipment Part 1-2 General Requirement on safety, Collateral Standard Requirements and Tests for Electromagnetic Compatibility and the device complied with the requirements.

Guidance and manufacturer's declaration-electromagnetic emissions		
<p>The model VHB20 Series is intended for use in the electromagnetic environment specified below. The customer or the user of the model VHB20 Series should assure that it is used in such an environment.</p>		
Emissions test	Compliance	Electromagnetic environment-guidance
RF emissions CISPR 11	Group 1	The model VHB20 Series uses RF energy only for its internal function. Therefore, its RF emissions are very low and are not likely to cause any interference in nearby electronic equipment.
RF emissions CISPR 11	Class B	The model VHB20 Series is suitable for use in all establishments other than domestic and those directly connected to the public low-voltage power supply network that supplies buildings used for domestic purposes.
Harmonic Emissions IEC 61000-3-2	Compliance	
Voltage fluctuations / flicker emissions IEC 61000-3-3	Compliance	

Guidance & Declaration – electromagnetic immunity

The model VHB20 Series is intended for use in the electromagnetic environment specified below. The customer or the user of the model VHB20 Series should assure that it is used in such an environment.

Immunity test	IEC 60601 test level	Compliance level	Electromagnetic environment -guidance
Electrostatic discharge (ESD) IEC 61000-4-2	±8 kV contact ±2 kV,±4 kV,±8 kV, ±15 kV air	±8 kV contact ±2 kV,±4 kV,±8 kV,±15 kV air	Floor should be wood, concrete or ceramic tile. If floors are covered with synthetic material, the relative humidity should be at least 30%.
Electrical fast transient/burst IEC 61000-4-4	±2kV for power supply lines ±1 kV for Input/output lines	±2kV for power supply lines ±1 kV Input/output lines	Mains power quality should be that of a typical commercial or hospital environment
Surge IEC 61000-4-5	±0.5 kV & ±1 kV differential mode ±0.5 kV,±1 kV&±2 kV common mode	±0.5 kV & ±1 kV differential mode ±0.5 kV,±1 kV& ±2 kV common mode	Mains power quality should be that of a typical commercial or hospital environment
Voltage dips, short interruptions and voltage variations on power supply input lines IEC 61000-4-11.	100% U_T (100% dip in U_T) for 0.5 cycle 100% U_T (100% dip in U_T) for 1 cycle 30% U_T (70% dip in U_T) for 25/30 cycles 100% U_T (100% dip in U_T) for 250/300 cycle	100% U_T (100% dip in U_T) for 0.5 cycle 100% U_T (100% dip in U_T) for 1 cycle 30% U_T (70% dip in U_T) for 25/30 cycles 100% U_T (100% dip in U_T) for 250/300 cycle	Mains power quality should be that of a typical commercial or hospital environment. If the user of the model VHB20 Series requires continued operation during power mains interruptions, it is recommended that the model VHB20 Series be powered from an uninterruptible power supply or battery.
Power frequency (50/60 Hz) magnetic field IEC 61000-4-8	30 A/m	30 A/m	Power frequency magnetic fields should be at levels characteristic of a typical location in a typical commercial or hospital environment.

NOTE: U_T is the a.c. mains voltage prior to application of the test level.

Guidance & Declaration – Electromagnetic immunity

The model VHB20 Series is intended for use in the electromagnetic environment specified below. The customer or the user of the model VHB20 Series should assure that it is used in such an environment.

Immunity test	IEC 60601 test level	Compliance level	Electromagnetic environment -guidance
Conducted RF IEC 61000-4-6 Radiated RF IEC 61000-4-3	3 Vrms 150 kHz to 80 MHz 6 Vrms in ISM bands 3 V/m 80MHz to 2.7 GHz 385MHz-5785MHz Test specifications for ENCLOSURE PORT IMMUNITY to RF wireless communication equipment (Refer to table 9 of IEC 60601-1-2:2014)	3 Vrms 150 kHz to 80 MHz 6 Vrms in ISM bands 3 V/m 80MHz to 2.7 GHz 385MHz-5785MHz Test specifications for ENCLOSURE PORT IMMUNITY to RF wireless communication equipment (Refer to table 9 of IEC 60601-1-2:2014)	Portable and mobile RF communications equipment should be used no closer to any part of the model VHB20 Series, including cables, than the recommended separation distance calculated from the equation applicable to the frequency of the transmitter. Recommended separation distance $d = 1.2 \times P^{1/2}$ 80 MHz to 800 MHz $d = 1.2 \times P^{1/2}$ 80 MHz to 2.5 GHz where P is the maximum output power rating of the transmitter in watts (W) according to the transmitter manufacturer and is the recommended separation distance in meters (m). Field strengths from fixed RF transmitters, as determined by an electromagnetic site survey ^a , should be less than the compliance level in each frequency range ^b . Interference may occur in the vicinity of equipment marked with the following symbol:

NOTE 1 At 80 MHz end 800 MHz. the higher frequency range applies. **NOTE 2** These guidelines may not apply in all situations. Electromagnetic propagation is affected by absorption and reflection from structures, objects and people.

^a Field strengths from fixed transmitters, such as base stations for a radio (cellular/cordless) telephones and land mobile radios, amateur radio, AM and FM radio broadcast and TV broadcast cannot be predicted theoretically with accuracy. To assess the electromagnetic environment due to fixed RF transmitters, and electromagnetic site survey should be considered. If the measured field strength in the location in which the model VHB20 Series is used exceeds the applicable RF compliance level above, model VHB20 Series should be observed to verify normal operation. If abnormal performance is observed, additional measures may be necessary, such as reorienting or relocating the model VHB20 Series.

^b Over the frequency range 150 kHz to 80 MHz, field strengths should be less than 3V/m



Recommended separation distances between portable and mobile RF communications equipment and the model VHB20 Series.

The model VHB20 Series is intended for use in an electromagnetic environment in which radiated RF disturbances are controlled. The customer or the user of the model VHB20 Series can help prevent electromagnetic interference by maintaining a minimum distance between portable and mobile RF communications equipment (transmitters) and the model VHB20 Series as recommended below, according to the maximum putput power of the communications equipment.

Rated maximum output power of transmitter W	Separation distance according to frequency of transmitter m		
	150kHz to 80MHz $d=1.2 \times P^{1/2}$	80MHz to 800MHz $d=1.2 \times P^{1/2}$	800MHz to 2.5GHz $d=2.3 \times P^{1/2}$
0,01	0.12	0.12	0.23
0,1	0.38	0.38	0.73
1	1.2	1.2	2.3
10	3.8	3.8	7.3
100	12	12	23

For transmitter rated at a maximum output power not listed above, the recommended separation (d) in meters (m) can be estimated using the equation applicable to the frequency of the transmitter, where P is the maximum output power rating of the transmitter in watts (W) according to the transmitter manufacturer.

NOTE 1 At 80 MHz and 800 MHz. the separation distance for the higher frequency range applies.

NOTE 2 These guidelines may not apply in all situations. Electromagnetic propagation is affected by absorption and the reflection from structures, objects and people.

Chapter 8 USE AND WARRANTY PERIOD

Do not disassemble the device. The warranty period is 1 year from the date of purchase. The warranty period for the temperature-humidity data / sensor cable is 6 months. During the warranty period, the warranty is void under the following conditions:

1. An error caused by operating the unit in a non-prescribed condition or application.
2. Damage or injury caused by not complying with the provisions of the power supply requirements,
3. Damage or injury caused by installation, modification or repair from Non-authorized service engineers or technicians.
4. Damage or injury caused by natural disasters such as fire, earthquake power surge, lightening, flood, etc.
5. When the machine develops a fault, please contact your supplier remove second or Vincent Medical Manufacturing Co., Ltd. for maintenance.



Vincent Medical manufacturing Co., Ltd.

Flat/RM B2, 7/F., Hang Fung Industrial Building, Phase 2,

2G Hok Yuen Street, Hung Hom, Kowloon, Hong Kong

Tel: +852 2365 5688

Fax: +852 2765 8428

EC REP

Obelis s.a

Bd Général Wahis 53 1030 Brussels, Belgium

Tel: +32 2 732 59 54 Fax: +32 2 732 60 03

